

Varenummer: 4395000801  
Beskrivelse: Rota-fix spændelement F80x120  
Rustfast stål

## Mål

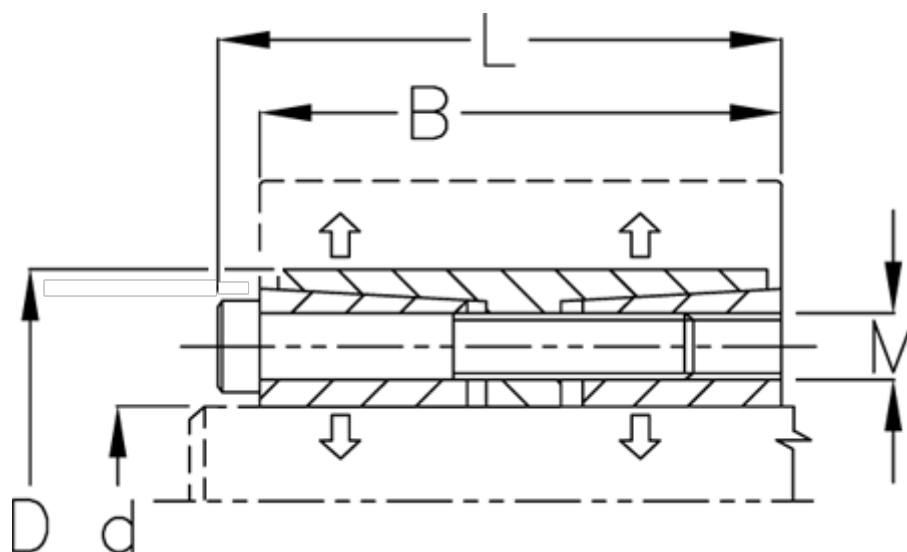

B mm	= 80
d H8 mm	= 80
D mm	= 120
F kN aksialkraft	= 197.0
L mm	= 90
M mm	= M10
Overfladeruhed	= R? ? 3.2 $\mu$ m
P N/mm <sup>2</sup> fladetryk på aksel/nav	= 37

T Nm drejningsmoment	= 7880
Tolerance	= Aksel h8, Nav H8
Ts Nm boltetilspændingsmoment	= 58.0